

TEST REPORT

CERTIFICATE OF CONFORMITY

Standard: ICES-003: 2020 Issue 7, Class A

ICES-Gen: 2024 Issue 2

ANSI C63.4-2014 amended as per ANSI C63.4a-2017

Report No.: CIBDBO-WTW-P25010534

Product: Industrial Motherboards

Brand: Vecow

Model No.: EMBC-7000

Series Model: EMBC-7XXXXXXXXXXXXX ("X" can be 0-9, A-Z or blank for marketing purpose)

Received Date: 2024/10/21

Test Date: 2024/10/24 ~ 2024/10/25

Issued Date: 2025/2/5

Applicant: Vecow Co., Ltd.

Address: 3F., No. 10, Jiankang Rd., Zhonghe Dist., New Taipei City 23586, Taiwan

Issued By: Bureau Veritas Consumer Products Services (H.K.) Ltd., Taoyuan Branch
Lin Kou Laboratories

Lab Address: No. 47-2, 14th Ling, Chia Pau Vil., Lin Kou Dist., New Taipei City, Taiwan

Test Location: No. 47-2, 14th Ling, Chia Pau Vil., Lin Kou Dist., New Taipei City, Taiwan

Approved by: _____

Jim Hsiang

Date: _____

2025/2/5

Jim Hsiang / Associate Technical Manager

This test report consists of 29 pages in total. It may be duplicated completely for legal use with the approval of the applicant. It should not be reproduced except in full, without the written approval of our laboratory. The test results in the report only apply to the tested sample. The test results in this report are traceable to the national or international standards.

Prepared by : Vivian Chen / Senior Specialist



This report is governed by, and incorporates by reference, the Conditions of Testing as posted at the date of issuance of this report at <http://www.bureauveritas.com/home/about-us/our-business/cps/about-us/terms-conditions/>, and is intended for your exclusive use. Any copying or replication of this report to or for any other person or entity, or use of our name or trademark, is permitted only with our prior written permission. This report sets forth our findings solely with respect to the test samples identified herein. The results set forth in this report are not indicative or representative of the quality or characteristics of the lot from which a test sample was taken or any similar or identical product unless specifically and expressly noted. Our report includes all of the tests requested by you and the results thereof based upon the information that you provided to us. Measurement uncertainty is only provided upon request for accredited tests. Statements of conformity are based on simple acceptance criteria without taking measurement uncertainty into account, unless otherwise requested in writing. You have 60 days from date of issuance of this report to notify us of any material error or omission caused by our negligence or if you require measurement uncertainty; provided, however, that such notice shall be in writing and shall specifically address the issue you wish to raise. A failure to raise such issue within the prescribed time shall constitute your unqualified acceptance of the completeness of this report, the tests conducted and the correctness of the report contents.

Table of Contents

Release Control Record	3
1 Certificate.....	4
2 Summary of Test Results	5
2.1 Measurement Uncertainty	5
2.2 Supplementary Information	5
3 General Information	6
3.1 Description of EUT	6
3.2 Primary Clock Frequencies of Internal Source.....	6
3.3 Features of EUT	6
3.4 Operating Modes of EUT and Determination of Worst Case Operating Mode	7
3.5 Test Program Used and Operation Descriptions	8
3.6 Connection Diagram of EUT and Peripheral Devices	8
3.7 Configuration of Peripheral Devices and Cable Connections	9
4 Test Instruments	10
4.1 Conducted Emissions from Power Ports.....	10
4.2 Radiated Emissions up to 1 GHz	11
4.3 Radiated Emissions above 1 GHz.....	12
5 Limits of Test Items.....	13
5.1 Conducted Emissions from Power Ports.....	13
5.2 Radiated Emissions up to 1 GHz	13
5.3 Radiated Emissions above 1 GHz.....	13
6 Test Arrangements.....	14
6.1 Conducted Emissions from Power Ports.....	14
6.2 Radiated Emissions up to 1 GHz	15
6.3 Radiated Emissions above 1 GHz.....	16
7 Test Results of Test Item	17
7.1 Conducted Emissions from Power Ports.....	17
7.2 Radiated Emissions up to 1 GHz	21
7.3 Radiated Emissions above 1 GHz.....	23
8 Pictures of Test Arrangements	25
8.1 Conducted Emissions from Power Ports.....	25
8.2 Radiated Emissions up to 1 GHz	27
8.3 Radiated Emissions above 1 GHz.....	28
9 Information of the Testing Laboratories	29



Release Control Record

Issue No.	Description	Date Issued
CIBDBO-WTW-P25010534	Original release.	2025/2/5

1 Certificate

Product: Industrial Motherboards

Brand: Vecow

Test Model: EMBC-7000

Series Model: EMBC-7XXXXXXXXXXXXX ("X" can be 0-9, A-Z or blank for marketing purpose)

Sample Status: Engineering sample

Applicant: Vecow Co., Ltd.

Test Date: 2024/10/24 ~ 2024/10/25

Standard: ICES-003: 2020 Issue 7, Class A

ICES-Gen: 2024 Issue 2

ANSI C63.4-2014 amended as per ANSI C63.4a-2017

The above equipment has been tested by **Bureau Veritas Consumer Products Services (H.K.) Ltd., Taoyuan Branch**, and found compliance with the requirement of the above standards. The test record, data evaluation & Equipment Under Test (EUT) configurations represented herein are true and accurate accounts of the measurements of the sample's EMC characteristics under the conditions specified in this report.

2 Summary of Test Results

The test items that the EUT need to perform in accordance with its interfaces, evaluated functions, are as follows:

Standard	Test Item	Result	Remark
ICES-003	Conducted Emissions from Power Ports	Pass	Minimum passing Class A margin is -16.16 dB at 0.46413 MHz
ICES-003	Radiated Emissions up to 1 GHz	Pass	Minimum passing Class A margin is -9.74 dB at 51.02 MHz
ICES-003	Radiated Emissions above 1 GHz	Pass	Minimum passing Class A margin is -16.01 dB at 2092.99 MHz

Note: Determining compliance based on the results of the compliance measurement, not taking into account measurement instrumentation uncertainty.

2.1 Measurement Uncertainty

Where relevant, the following measurement uncertainty levels have been estimated for tests performed on the EUT as specified in CISPR 16-4-2:

Measurement	Specification	Expanded Uncertainty (k=2) (±)	Maximum allowable uncertainty (±)
Conducted Emissions from Power Ports	9 kHz ~ 30 MHz	2.9 dB	3.4 dB (U_{CISPR})
Radiated Emissions up to 1 GHz	30 MHz ~ 1 GHz	3m : 5.44 dB 10m : 4.00 dB	6.3 dB (U_{CISPR})
	1 GHz ~ 6 GHz	4.44 dB	5.2 dB (U_{CISPR})
Radiated Emissions above 1 GHz	6 GHz ~ 18 GHz	4.66 dB	5.5 dB (U_{CISPR})

The other instruments specified are routine verified to remain within the calibrated levels, no measurement uncertainty is required to be calculated.

2.2 Supplementary Information

There is not any deviation from the test standards for the test method, and no modifications required for compliance.

3 General Information

3.1 Description of EUT

Product	Industrial Motherboards
Brand	Vecow
Test Model	EMBC-7000
Series Model	EMBC-7XXXXXXXXXXXXX ("X" can be 0-9, A-Z or blank for marketing purpose)
Model Difference	Marketing Differentiation
Sample Status	Engineering sample
Operating Software	N/A
Test Program	N/A
Power Supply Rating	DC from host equipment

Note:

1. The all test data are copied from the test report (BV CPS report no.: CIBDBO-WTW-P24100426). And all data was verified to meet the standard version.
2. The EUT is an Industrial Motherboard.
3. The EUT was installed into the following host equipment (provided by client) for the test:

Host equipment: SPC-9100	
Component	Specification
CPU	Intel® Core™ Ultra 7 165U 1.70 GHz
RAM	Transcend DDR5 SODIMM 32GB PC5-5600B-SBO-1010-IT
SSD	Innodisk M.2(P80) 4TG2-P 1TB
Industrial Motherboards	Vecow, EMBC-7000 (EUT)

3.2 Primary Clock Frequencies of Internal Source

The highest frequency generated or used within the EUT or on which the EUT operates or tunes is 1.7 GHz, provided by Vecow Co., Ltd., for detailed internal source, please refer to the manufacturer's specifications.

3.3 Features of EUT

The tests reported herein were performed according to the method specified by Vecow Co., Ltd., for detailed feature description, please refer to the manufacturer's specifications or user's manual.

Please refer to appendix of the report if the applicant has provided additional descriptions of the EUT.

3.4 Operating Modes of EUT and Determination of Worst Case Operating Mode

The EUT has been pre-tested under following test modes.

Test Condition	
Mode	Radiated Emissions up to 1 GHz
1	Full system,(HDMI+DP):3840*2160,60Hz,LAN 2.5G link + Type-C:3840*2160,60Hz
2	Full system,(HDMI+DP):3840*2160,60Hz,LAN 2.5G link + Type-C:R/W
Note: The worst case is mode 2 shown in bold.	

Test modes are presented in the report as below.

Test Condition	
Mode	Conducted Emissions from Power Ports
A	Full system,(HDMI+DP):3840*2160,60Hz,LAN 2.5G link + Type-C:R/W + Input Power(120 Vac, 60 Hz)
B	Full system,(HDMI+DP):3840*2160,60Hz,LAN 2.5G link + Type-C:R/W + Input Power(240 Vac, 60 Hz)
Mode	Radiated Emissions up to 1 GHz
A	Full system,(HDMI+DP):3840*2160,60Hz,LAN 2.5G link + Type-C:R/W + Input Power(120 Vac, 60 Hz)
Mode	Radiated Emissions above 1 GHz
A	Full system,(HDMI+DP):3840*2160,60Hz,LAN 2.5G link + Type-C:R/W + Input Power(120 Vac, 60 Hz)

3.5 Test Program Used and Operation Descriptions

- a. Installed EUT into host equipment.
- b. Turned on the power of all equipment.
- c. Host equipment ran test program (Burnintest) to enable all functions.
- d. Host equipment read and wrote messages to/ from internal storage devices, external storage devices.
- e. PC (kept in a remote area) sent and received messages to/ from Host equipment via LAN cable.
- f. Host equipment sent (H) messages to monitor, then they displayed message on their screens simultaneously.
- g. Host equipment sent (1kHz audio) signal to earphone.

3.6 Connection Diagram of EUT and Peripheral Devices

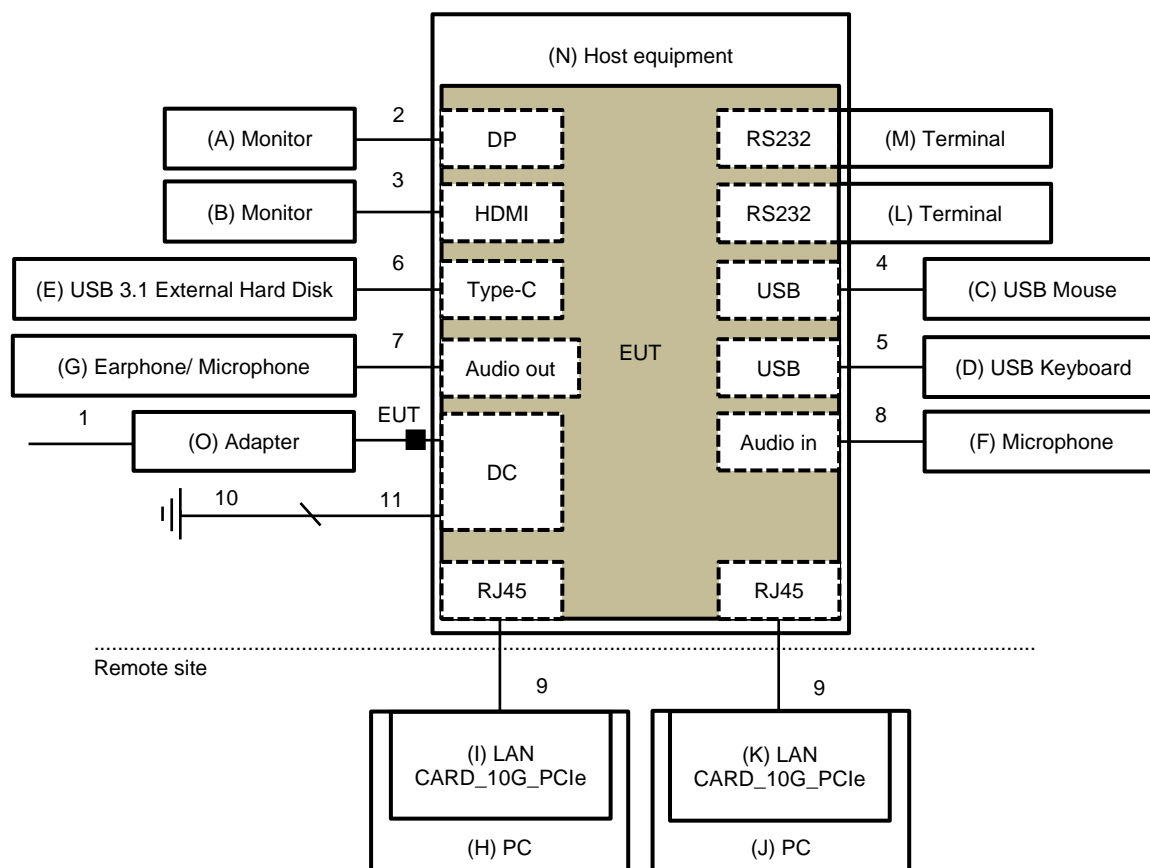

3.7 Configuration of Peripheral Devices and Cable Connections

ID	Product	Brand	Model No.	Serial No.	FCC ID	Remarks
A	Monitor	ASUS	PA279CV	M7LMTF235926	DoC	Provided by Lab
B	Monitor	ASUS	PA279CV	M7LMTF235971	DoC	Provided by Lab
C	USB Mouse	DELL	MOCZUL	CN-049TWY- PRC00-77B-007R	N/A	Provided by Lab
D	USB Keyboard	Dell	KB216t	CN-0W33XP- LO300-7CL-191E	N/A	Provided by Lab
E	USB 3.1 External Hard Disk	Transcend	SSD220S	SK21D1718X0057	DoC	Provided by Lab
F	Microphone	E-books	E-EPB099	N/A	N/A	Provided by Lab
G	Earphone/ Microphone	OPPO	L1516	N/A	N/A	Provided by Lab
H	PC	DELL	VOSTRO 470	1WBJYBX	DoC	Provided by Lab
I	LAN CARD_10G_PCIe	ASUS	XG-C100C	K5QSRT001889	DoC	Provided by Lab
J	PC	DELL	VOSTRO 470	7VBJYBX	DoC	Provided by Lab
K	LAN CARD_10G_PCIe	ASUS	XG-C100C	K5QSRT001882	DoC	Provided by Lab
L	Terminal	N/A	N/A	N/A	N/A	Supplied by applicant
M	Terminal	N/A	N/A	N/A	N/A	Supplied by applicant
N	Host equipment	Vecow	SPC-7000	NA	NA	Supplied by applicant
O	Adapter	FSP	FSP120-AAAN2	NA	NA	Supplied by applicant

ID	Cable Descriptions	Qty.	Length (m)	Shielding (Yes/No)	Cores (Qty.)	Remarks
1	Power	1	1.8	N	0	Provided by Lab
2	DP	1	1.8	Y	0	Provided by Lab
3	HDMI	1	2	Y	0	Provided by Lab
4	USB	1	1.8	Y	0	Provided by Lab
5	USB	1	1.8	Y	0	Provided by Lab
6	Type C	1	1.5	Y	0	Provided by Lab
7	Audio	1	1	N	0	Provided by Lab
8	Audio	1	2	N	0	Provided by Lab
9	Cat. 5e	2	10	Y	0	Provided by Lab
10	GND (PE)	1	1.5	N	0	Provided by Lab
11	GND (PE)	1	0.1	N	0	Supplied by applicant

4 Test Instruments

The calibration interval of the all test instruments are 12 months and the calibrations are traceable to NML/ROC and NIST/USA.

4.1 Conducted Emissions from Power Ports

Description Manufacturer	Model No.	Serial No.	Calibrated Date	Calibrated Until
* Isolation Transformer Erika Fiedler	D-65396	46	2023/4/20	2025/4/19
50 ohm terminal resistance LYNICS	0900510	E1-01-300	2024/1/31	2025/1/30
		E1-01-301	2024/1/31	2025/1/30
		E1-011284	2024/9/16	2025/9/15
Coupling / Decoupling Network Schwarzbeck	CDNE-M2	00097	2024/5/28	2025/5/27
	CDNE-M3	00091	2024/5/28	2025/5/27
Coupling / Decoupling Network TESEQ	CDN A201A	44601	2023/12/14	2024/12/13
EMI Test Receiver R&S	ESR3	102413	2024/1/29	2025/1/28
Fixed Attenuator EMEC	EM-ATT30002602NN	N/A	2024/3/22	2025/3/21
Fixed Attenuator STI	STI02-2200-10	NO.3	2024/10/19	2025/10/18
High Voltage Probe Schwarzbeck	TK9420	00982	2023/12/11	2024/12/10
Isolation Transformer Erika Fiedler	D-65396	017	2024/9/18	2025/9/17
LISN R&S	ENV216	101196	2024/5/22	2025/5/21
	ESH3-Z5	100220	2023/11/22	2024/11/21
LISN Schwarzbeck	NNLK 8121	8121-731	2024/6/12	2025/6/11
		8121-808	2024/4/26	2025/4/25
	NNLK 8129	8129229	2024/10/14	2025/10/13
RF Coaxial Cable PEWC	5D-FB	Cable-CO3-01	2024/9/12	2025/9/11
Software BVADT	Cond_V7.4.1.0	N/A	N/A	N/A
V-LISN Schwarzbeck	NNBL 8226-2	8226-142	2024/8/28	2025/8/27

Notes:

- * The calibration interval of the above test instruments is 24 months and the calibrations are traceable to NML/ROC and NIST/USA
- The test was performed in Linkou Conduction 3.
- The VCCI Site Registration No. C-10274.
- Tested Date: 2024/10/25

4.2 Radiated Emissions up to 1 GHz

Description Manufacturer	Model No.	Serial No.	Calibrated Date	Calibrated Until
ADT. Tower	AT100	0205	N/A	N/A
ADT. Turn Table	TT100	0205	N/A	N/A
Bi_Log Antenna Schwarzbeck	VULB 9168	9168-303	2024/10/14	2025/10/13
Coupling / Decoupling Network Schwarzbeck	CDNE-M2	00097	2024/5/28	2025/5/27
	CDNE-M3	00091	2024/5/28	2025/5/27
EMI Test Receiver R&S	ESCS 30	100276	2024/4/24	2025/4/23
Fixed Attenuator Mini-Circuits	UNAT-5+	PAD-ST2-01	2024/10/19	2025/10/18
Preamplifier HP	8447D	2944A08119	2024/2/15	2025/2/14
RF Coaxial Cable Pacific	8D-FB	Cable-ST2-01	2023/11/7	2024/11/6
Software BVADT	Radiated_V8.8.09	N/A	N/A	N/A

Notes:

1. The test was performed in Linkou Open Site 2. The test site validated date: 2024/7/13 (NSA).
2. The VCCI Site Registration No. R-10237.
3. Tested Date: 2024/10/25

4.3 Radiated Emissions above 1 GHz

Description Manufacturer	Model No.	Serial No.	Calibrated Date	Calibrated Until
Fix tool for Boresight antenna tower BV	BAF-01	9	N/A	N/A
Fixed Attenuator Mini-Circuits	BW-K3-2W44+	PAD-CH7-03	2024/7/5	2025/7/4
	BW-N4W5+	PAD-CH10-02	2024/7/5	2025/7/4
Horn Antenna EMCO	3115	6714	2023/11/12	2024/11/11
Horn Antenna ETS-Lindgren	3117-PA	00215857	2023/11/12	2024/11/11
Horn Antenna Schwarzbeck	BBHA 9170	BBHA9170190	2023/11/12	2024/11/11
MXA Signal Analyzer Keysight	N9020B	MY60110438	2023/11/28	2024/11/27
		MY60112260	2024/5/29	2025/5/28
Notch Filter Micro-Tronics	BRC50703-01	010	2024/5/24	2025/5/23
	BRM17690	005	2024/5/24	2025/5/23
Preamplifier EMCI	EMC0126545	980076	2024/2/15	2025/2/14
	EMC184045B	980235	2024/2/15	2025/2/14
Preamplifier HP	8449B	3008A01292	2024/2/15	2025/2/14
RF Coaxial Cable EMEC	EM102-KMKM-100	02	2024/7/5	2025/7/4
	EM102-KMKM-350	01	2024/7/5	2025/7/4
Software BVADT	Radiated_V8.8.09	N/A	N/A	N/A
Turn Table & Tower Max Full	MF7802	MF780208216	N/A	N/A

Notes:

1. The test was performed in Linkou 966 Chamber 3 (CH 10).
2. The VCCI Site Registration No. G-10427.
3. Tested Date: 2024/10/24

5 Limits of Test Items

5.1 Conducted Emissions from Power Ports

Frequency (MHz)	Class A (dBuV)		Class B (dBuV)	
	Quasi-peak	Average	Quasi-peak	Average
0.15 - 0.5	79	66	66 - 56	56 - 46
0.50 - 5.0	73	60	56	46
5.0 - 30.0	73	60	60	50

Notes: 1. The lower limit shall apply at the transition frequencies.
 2. The limit decreases linearly with the logarithm of the frequency in the range of 0.15 to 0.50 MHz.

5.2 Radiated Emissions up to 1 GHz

Frequency range (MHz)	Class A (3 m) Quasi-peak dB μ V/m	Class A (10 m) Quasi-peak dB μ V/m	Class B (3 m) Quasi-peak dB μ V/m	Class B (10 m) Quasi-peak dB μ V/m
30-88	50.0	40.0	40.0	30.0
88-216	54.0	43.5	43.5	33.1
216-230	56.9	46.4	46.0	35.6
230-960	57.0	47.0	47.0	37.0
960-1000	60.0	49.5	54.0	43.5

Notes: 1. The lower limit shall apply at the transition frequencies.

5.3 Radiated Emissions above 1 GHz

Required highest measurement frequency

Highest internal frequency (F_x)	Highest measurement frequency (F_M) (GHz)
$F_x \leq 108$ MHz	1
108 MHz < $F_x \leq 500$ MHz	2
500 MHz < $F_x \leq 1$ GHz	5
$F_x > 1$ GHz	5 x F_x up to a maximum of 40 GHz

F_x is the highest fundamental frequency generated and/or used in the ITE or digital apparatus under test.

Radiated Emissions Limits at 3 meters (dB μ V/m)		
Frequency range (GHz)	Class A	Class B
1 - F_M	Avg: 60 Peak: 80	Avg: 54 Peak: 74

Notes: 1. These limit levels apply for a measurement distance of 3 m. If using a different measurement distance, the measured levels shall be extrapolated to the 3 m limit distance using a factor of 20 dB per decade of distance. The measurement distance shall place the measurement antenna in the far field of the ITE or digital apparatus under test.

At and above 1 GHz, if the ITE or digital apparatus is an outdoor unit of home satellite receiving systems, it shall comply with the limits in Table A.7 in clause A.2 of CAN/CSA-CISPR 32:17 (in Annex A therein). For these types of ITE or digital apparatus, the highest measurement frequency shall be 18 GHz.

6 Test Arrangements

6.1 Conducted Emissions from Power Ports

- For the table-top EUT is placed on a 0.8 meter insulation table; for the floor standing EUT shall be insulated (by insulation of 12 mm) from the horizontal reference ground plane. The EUT is placed 0.4 meters from the conducting wall of the shielded room with EUT being connected to the power mains through a line impedance stabilization network (LISN). Other support units are connected to the power mains through another LISN. They provide coupling impedance for the measuring instrument.
- Both lines of the power mains connected to the EUT were checked for maximum conducted interference.
- The test results of conducted emissions at mains ports are recorded of six worst margins for quasi-peak (mandatory) [and average (if necessary)] values against the limits at frequencies of interest unless the margin is 20 dB or greater.

Note: The resolution bandwidth and video bandwidth of test receiver is 9kHz for quasi-peak detection (QP) and average detection (AV) at frequency 0.15MHz-30MHz.

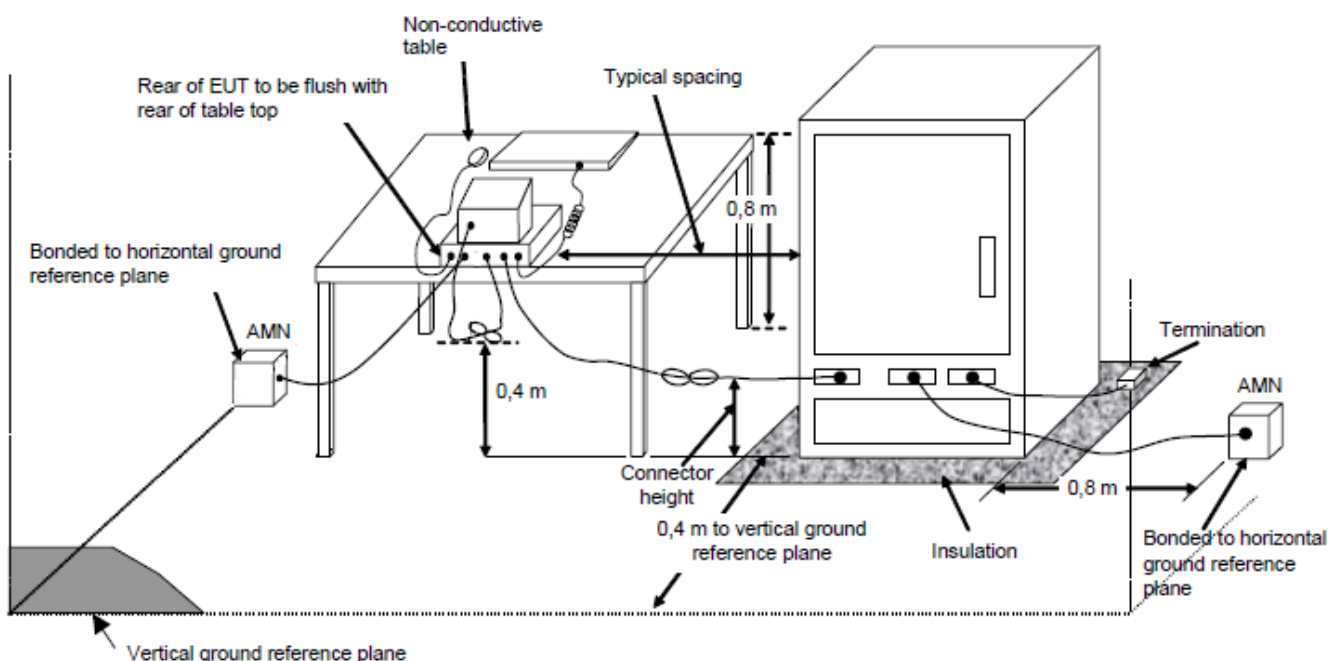

For the actual test configuration, please refer to the related Item – Photographs of the Test Configuration.

6.2 Radiated Emissions up to 1 GHz

- For the table-top EUT is placed on a 0.8 meter to the top of rotating table; for the floor standing EUT shall be insulated (by insulation of 12 mm) from the horizontal reference ground plane. The rotating table is rotated 360 degrees to determine the position of the highest radiation. If the equipment requires a dedicated ground connection, this shall be provided and bonded to the RGP.
- The EUT was set 10 meters away from the interference-receiving antenna, which was mounted on the top of a variable-height antenna tower.
- The antenna is a broadband antenna, and its height is varied from one meter to four meters above the ground to determine the maximum value of the field strength. Both horizontal and vertical polarizations of the antenna are set to make the measurement.
- For each suspected emission, the EUT was arranged to its worst case and then the antenna was tuned to heights from 1 meter to 4 meters and the rotatable table was turned from 0 degrees to 360 degrees to find the maximum reading.
- The test-receiver system was set to quasi-peak detect function and specified bandwidth with maximum hold mode when the test frequency is up to 1 GHz.

Note: The resolution bandwidth and video bandwidth of test receiver/spectrum analyzer is 120kHz for quasi-peak detection (QP) at frequency up to 1GHz.

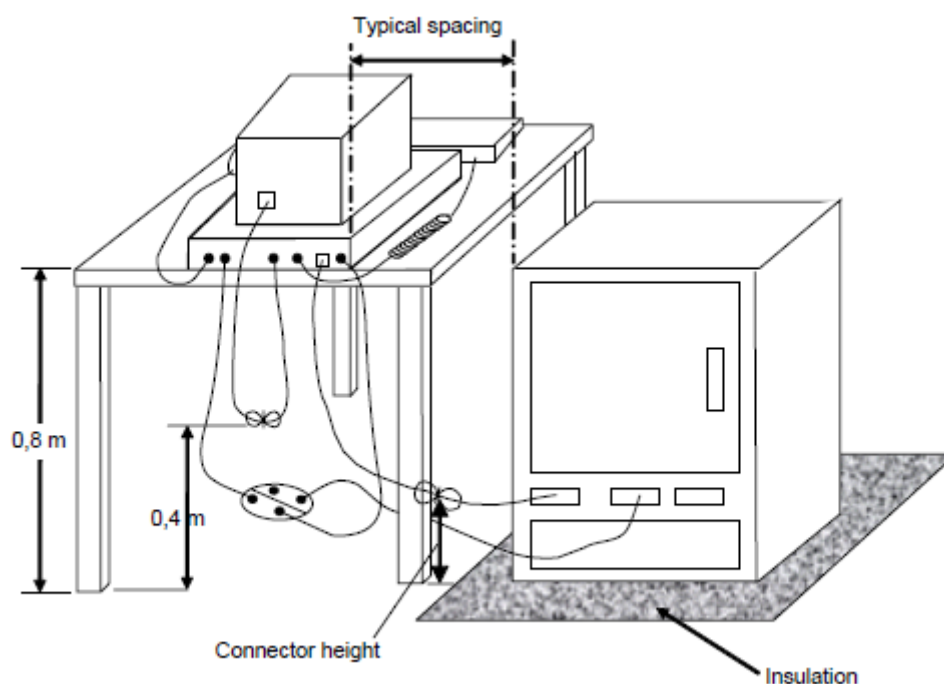

For the actual test configuration, please refer to the related Item – Photographs of the Test Configuration.

6.3 Radiated Emissions above 1 GHz

- For the table-top EUT is placed on a 0.8 meter to the top of rotating table; for the floor standing EUT shall be insulated (by insulation of 12 mm) from the horizontal reference ground plane. The rotating table is rotated 360 degrees to determine the position of the highest radiation. If the equipment requires a dedicated ground connection, this shall be provided and bonded to the RGP.
- The EUT was set $d = 3$ meters away from the interference-receiving antenna, which was mounted on the top of a variable-height antenna tower.
- The height of antenna can be varied from one meter to four meters, the height of adjustment depends on the EUT height and the antenna 3dB beamwidth both, to detect the maximum value of the field strength. Both horizontal and vertical polarizations of the antenna are set to make the measurement.
- For each suspected emission, the EUT was arranged to its worst case and then the antenna was tuned to heights and the rotatable table was turned from 0 degrees to 360 degrees to find the maximum reading.
- The spectrum analyzer system was set to peak and average detects function and specified bandwidth with maximum hold mode when the test frequency is above 1 GHz.

Note: The resolution bandwidth of test receiver/spectrum analyzer is 1MHz and video bandwidth is 3MHz for Peak detection (PK) at frequency above 1GHz. The resolution bandwidth of test receiver/spectrum analyzer is 1 MHz for Average detection (AV) at frequency above 1GHz.

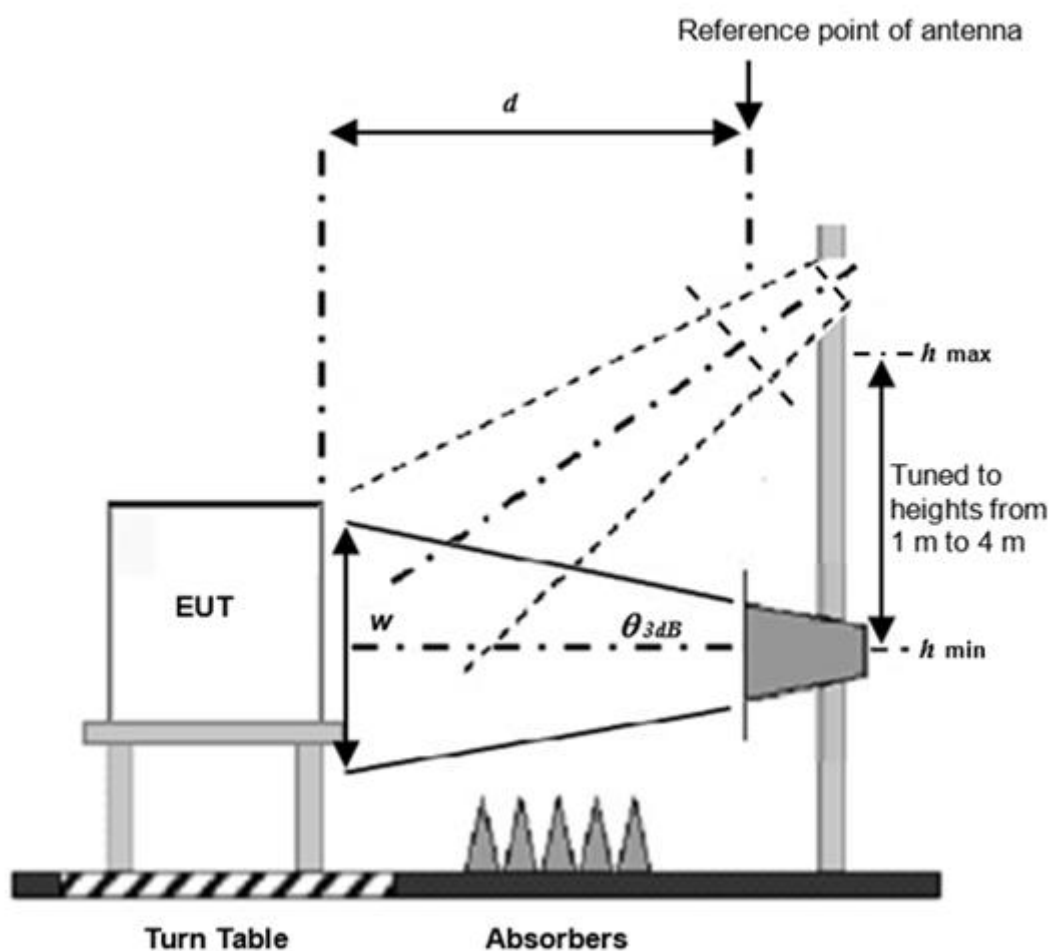

For the actual test configuration, please refer to the related item – Photographs of the Test Configuration.

7 Test Results of Test Item

7.1 Conducted Emissions from Power Ports

Mode A

Frequency Range	150 kHz ~ 30 MHz	Detector Function & Resolution Bandwidth	Quasi-Peak (QP) / Average (AV), 9 kHz
Input Power	120 Vac, 60 Hz	Environmental Conditions	25 °C, 75 % RH, 994.7 mbar
Tested by	Bernie Lu		

Phase Of Power : Line (L)										
No	Frequency (MHz)	Correction Factor (dB)	Reading Value (dBuV)		Emission Level (dBuV)		Limit (dBuV)		Margin (dB)	
			Q.P.	AV.	Q.P.	AV.	Q.P.	AV.	Q.P.	AV.
1	0.15391	8.80	36.21	30.93	45.01	39.73	79.00	66.00	-33.99	-26.27
2	0.41563	8.70	41.78	40.51	50.48	49.21	79.00	66.00	-28.52	-16.79
3	0.46413	8.70	41.46	41.14	50.16	49.84	79.00	66.00	-28.84	-16.16
4	0.51123	8.70	36.68	34.31	45.38	43.01	73.00	60.00	-27.62	-16.99
5	0.82747	8.69	35.78	32.33	44.47	41.02	73.00	60.00	-28.53	-18.98
6	1.19141	8.70	33.97	25.69	42.67	34.39	73.00	60.00	-30.33	-25.61

Remarks:

1. Q.P. and AV. are abbreviations of quasi-peak and average individually.
2. The emission levels of other frequencies were very low against the limit.
3. Margin value = Emission level – Limit value
4. Correction factor = Insertion loss + Cable loss
5. Emission Level = Correction Factor + Reading Value

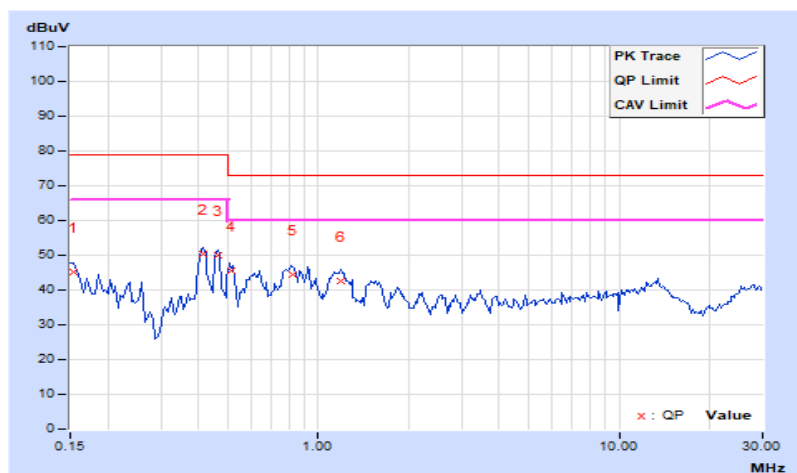

Frequency Range	150 kHz ~ 30 MHz	Detector Function & Resolution Bandwidth	Quasi-Peak (QP) / Average (AV), 9 kHz
Input Power	120 Vac, 60 Hz	Environmental Conditions	25 °C, 75 % RH, 994.7 mbar
Tested by	Bernie Lu		

Phase Of Power : Neutral (N)										
No	Frequency (MHz)	Correction Factor (dB)	Reading Value (dBuV)		Emission Level (dBuV)		Limit (dBuV)		Margin (dB)	
			Q.P.	AV.	Q.P.	AV.	Q.P.	AV.	Q.P.	AV.
1	0.15781	8.79	35.19	22.83	43.98	31.62	79.00	66.00	-35.02	-34.38
2	0.42633	8.70	40.19	38.89	48.89	47.59	79.00	66.00	-30.11	-18.41
3	0.47863	8.70	40.37	38.26	49.07	46.96	79.00	66.00	-29.93	-19.04
4	0.52642	8.70	33.41	29.69	42.11	38.39	73.00	60.00	-30.89	-21.61
5	0.81406	8.69	30.89	24.39	39.58	33.08	73.00	60.00	-33.42	-26.92
6	1.22656	8.68	28.59	21.22	37.27	29.90	73.00	60.00	-35.73	-30.10

Remarks:

1. Q.P. and AV. are abbreviations of quasi-peak and average individually.
2. The emission levels of other frequencies were very low against the limit.
3. Margin value = Emission level – Limit value
4. Correction factor = Insertion loss + Cable loss
5. Emission Level = Correction Factor + Reading Value

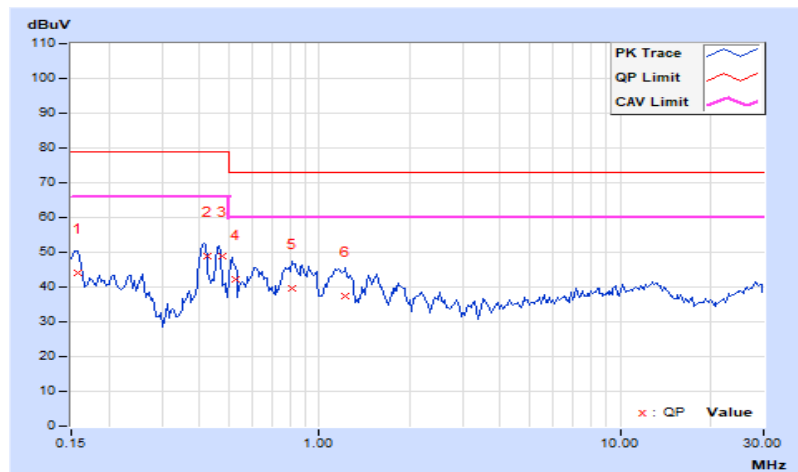

Mode B

Frequency Range	150 kHz ~ 30 MHz	Detector Function & Resolution Bandwidth	Quasi-Peak (QP) / Average (AV), 9 kHz
Input Power	240 Vac, 60 Hz	Environmental Conditions	25 °C, 75 % RH, 994.8 mbar
Tested by	Bernie Lu		

Phase Of Power : Line (L)										
No	Frequency (MHz)	Correction Factor (dB)	Reading Value (dBuV)		Emission Level (dBuV)		Limit (dBuV)		Margin (dB)	
			Q.P.	AV.	Q.P.	AV.	Q.P.	AV.	Q.P.	AV.
1	0.15391	8.80	39.39	24.54	48.19	33.34	79.00	66.00	-30.81	-32.66
2	0.42873	8.70	41.12	39.97	49.82	48.67	79.00	66.00	-29.18	-17.33
3	0.47812	8.70	41.36	38.40	50.06	47.10	79.00	66.00	-28.94	-18.90
4	0.61014	8.70	35.50	27.20	44.20	35.90	73.00	60.00	-28.80	-24.10
5	0.74531	8.69	35.51	27.82	44.20	36.51	73.00	60.00	-28.80	-23.49
6	1.17578	8.70	34.39	24.70	43.09	33.40	73.00	60.00	-29.91	-26.60

Remarks:

1. Q.P. and AV. are abbreviations of quasi-peak and average individually.
2. The emission levels of other frequencies were very low against the limit.
3. Margin value = Emission level – Limit value
4. Correction factor = Insertion loss + Cable loss
5. Emission Level = Correction Factor + Reading Value

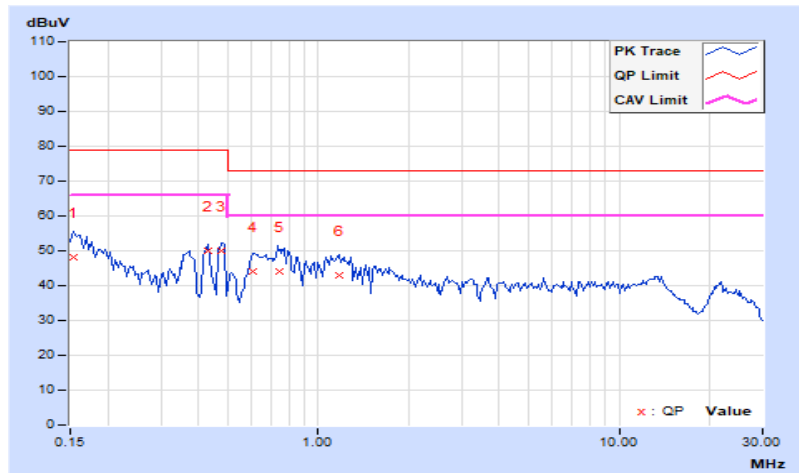

Frequency Range	150 kHz ~ 30 MHz	Detector Function & Resolution Bandwidth	Quasi-Peak (QP) / Average (AV), 9 kHz
Input Power	240 Vac, 60 Hz	Environmental Conditions	25 °C, 75 % RH, 994.7 mbar
Tested by	Bernie Lu		

Phase Of Power : Neutral (N)										
No	Frequency (MHz)	Correction Factor (dB)	Reading Value (dBuV)		Emission Level (dBuV)		Limit (dBuV)		Margin (dB)	
			Q.P.	AV.	Q.P.	AV.	Q.P.	AV.	Q.P.	AV.
1	0.15391	8.80	38.58	24.76	47.38	33.56	79.00	66.00	-31.62	-32.44
2	0.43125	8.70	41.05	37.71	49.75	46.41	79.00	66.00	-29.25	-19.59
3	0.47813	8.70	41.69	37.53	50.39	46.23	79.00	66.00	-28.61	-19.77
4	0.62656	8.69	35.93	26.66	44.62	35.35	73.00	60.00	-28.38	-24.65
5	1.09791	8.68	38.31	34.74	46.99	43.42	73.00	60.00	-26.01	-16.58
6	1.52234	8.69	34.90	34.08	43.59	42.77	73.00	60.00	-29.41	-17.23

Remarks:

1. Q.P. and AV. are abbreviations of quasi-peak and average individually.
2. The emission levels of other frequencies were very low against the limit.
3. Margin value = Emission level – Limit value
4. Correction factor = Insertion loss + Cable loss
5. Emission Level = Correction Factor + Reading Value

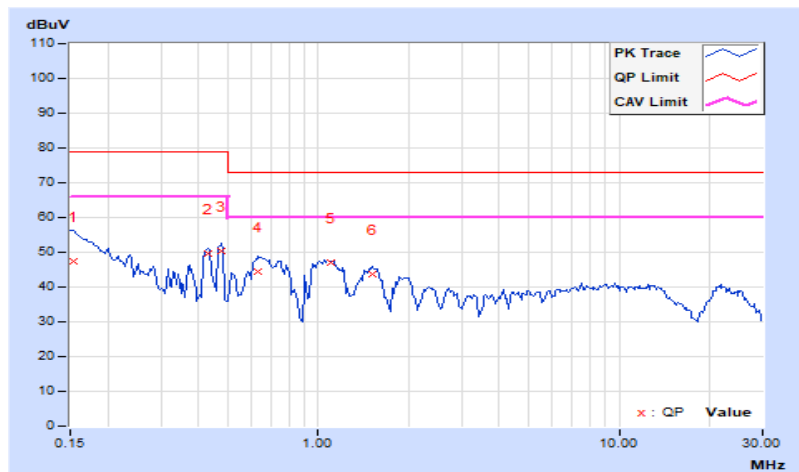

7.2 Radiated Emissions up to 1 GHz

Mode A

Frequency Range	30 MHz ~ 1 GHz	Detector Function & Resolution Bandwidth	Quasi-Peak (QP), 120 kHz
Input Power	120 Vac, 60 Hz	Environmental Conditions	23 °C, 69 % RH, 1000 mbar
Tested By	Paul Chen		

Antenna Polarity & Test Distance : Horizontal at 10 m								
No	Frequency (MHz)	Emission Level (dBuV/m)	Limit (dBuV/m)	Margin (dB)	Antenna Height (m)	Table Angle (Degree)	Raw Value (dBuV)	Correction Factor (dB/m)
1	51.02	30.26 QP	40.00	-9.74	4.00 H	339	38.55	-8.29
2	79.30	26.81 QP	40.00	-13.19	4.00 H	239	39.96	-13.15
3	113.98	25.92 QP	43.50	-17.58	4.00 H	66	36.37	-10.45
4	132.54	26.28 QP	43.50	-17.22	4.00 H	193	34.89	-8.61
5	175.89	28.43 QP	43.50	-15.07	4.00 H	330	36.75	-8.32
6	197.12	25.10 QP	43.50	-18.40	4.00 H	250	35.94	-10.84
7	316.27	31.75 QP	47.00	-15.25	3.18 H	209	37.43	-5.68
8	474.55	30.64 QP	47.00	-16.36	2.23 H	223	33.54	-2.90
9	539.90	33.89 QP	47.00	-13.11	1.83 H	234	35.74	-1.85
10	699.75	34.56 QP	47.00	-12.44	1.47 H	197	32.82	1.74
11	891.01	33.06 QP	47.00	-13.94	1.00 H	105	27.87	5.19

Remarks:

1. Emission Level(dBuV/m) = Raw Value(dBuV) + Correction Factor(dB/m)
2. Correction Factor(dB/m) = Antenna Factor (dB/m) + Cable Factor (dB)
– Pre-Amplifier Factor (dB)
3. Margin value = Emission level – Limit value
4. The other emission levels were very low against the limit.

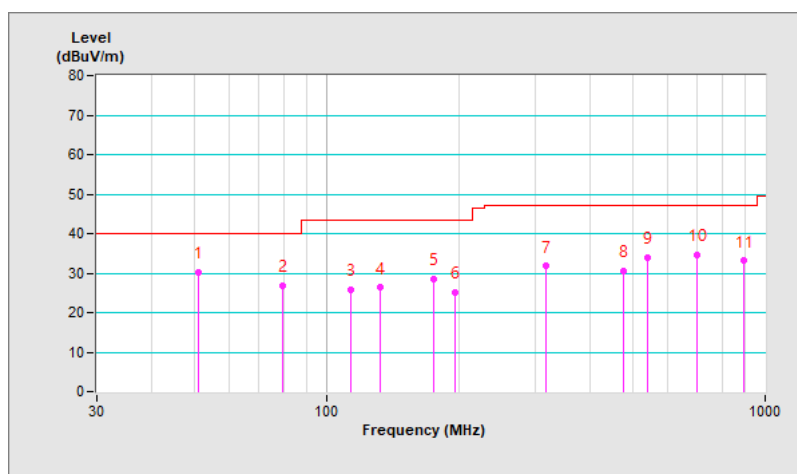

Frequency Range	30 MHz ~ 1 GHz	Detector Function & Resolution Bandwidth	Quasi-Peak (QP), 120 kHz
Input Power	120 Vac, 60 Hz	Environmental Conditions	23 °C, 69 % RH, 1000 mbar
Tested By	Paul Chen		

Antenna Polarity & Test Distance : Vertical at 10 m								
No	Frequency (MHz)	Emission Level (dBuV/m)	Limit (dBuV/m)	Margin (dB)	Antenna Height (m)	Table Angle (Degree)	Raw Value (dBuV)	Correction Factor (dB/m)
1	52.19	30.20 QP	40.00	-9.80	1.43 V	79	38.52	-8.32
2	108.63	27.41 QP	43.50	-16.09	1.00 V	268	38.39	-10.98
3	125.11	30.23 QP	43.50	-13.27	1.00 V	144	39.40	-9.17
4	157.44	27.02 QP	43.50	-16.48	1.00 V	0	34.27	-7.25
5	181.52	33.48 QP	43.50	-10.02	1.00 V	80	42.82	-9.34
6	223.92	27.83 QP	46.40	-18.57	1.00 V	305	38.21	-10.38
7	254.00	33.08 QP	47.00	-13.92	1.00 V	332	41.14	-8.06
8	327.30	31.17 QP	47.00	-15.83	1.00 V	159	36.57	-5.40
9	500.00	30.25 QP	47.00	-16.75	1.00 V	269	32.80	-2.55
10	699.23	32.84 QP	47.00	-14.16	3.28 V	231	31.11	1.73
11	891.00	34.82 QP	47.00	-12.18	2.26 V	227	29.63	5.19

Remarks:

1. Emission Level(dBuV/m) = Raw Value(dBuV) + Correction Factor(dB/m)
2. Correction Factor(dB/m) = Antenna Factor (dB/m) + Cable Factor (dB) – Pre-Amplifier Factor (dB)
3. Margin value = Emission level – Limit value
4. The other emission levels were very low against the limit.

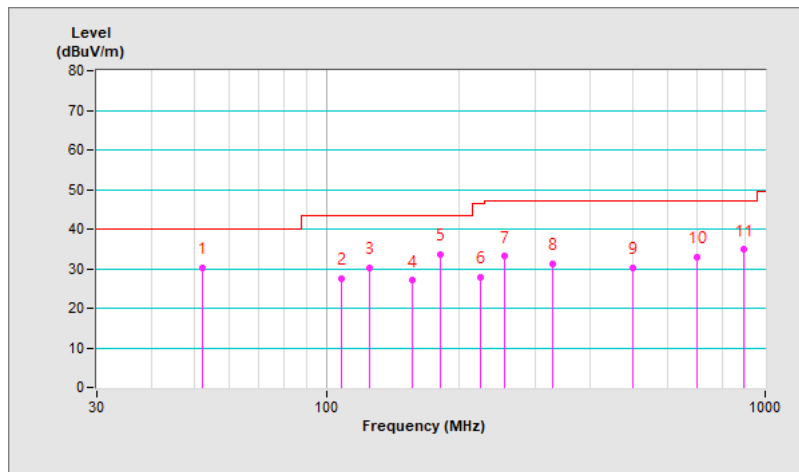

7.3 Radiated Emissions above 1 GHz

Mode A

Frequency Range	1 GHz ~ 18 GHz	Detector Function & Resolution Bandwidth	Peak (PK) / Average (AV), 1 MHz
Input Power	120 Vac, 60 Hz	Environmental Conditions	22 °C, 78 % RH, 1000.9 mbar
Tested By	Desmond Chen		

Antenna Polarity & Test Distance : Horizontal at 3 m								
No	Frequency (MHz)	Emission Level (dBuV/m)	Limit (dBuV/m)	Margin (dB)	Antenna Height (m)	Table Angle (Degree)	Raw Value (dBuV)	Correction Factor (dB/m)
1	2092.99	63.11 PK	80.00	-16.89	1.29 H	64	82.28	-19.17
2	2092.99	43.99 AV	60.00	-16.01	1.29 H	64	63.16	-19.17
3	3498.23	51.26 PK	80.00	-28.74	1.93 H	19	66.36	-15.10
4	3498.23	38.96 AV	60.00	-21.04	1.93 H	19	54.06	-15.10
5	8368.75	57.40 PK	80.00	-22.60	1.60 H	1	66.51	-9.11
6	8368.75	41.42 AV	60.00	-18.58	1.60 H	1	50.53	-9.11

Remarks:

1. Emission Level(dBuV/m) = Raw Value(dBuV) + Correction Factor(dB/m)
2. Correction Factor(dB/m) = Antenna Factor (dB/m) + Cable Factor (dB)
– Pre-Amplifier Factor (dB)
3. Margin value = Emission level – Limit value
4. The other emission levels were very low against the limit.

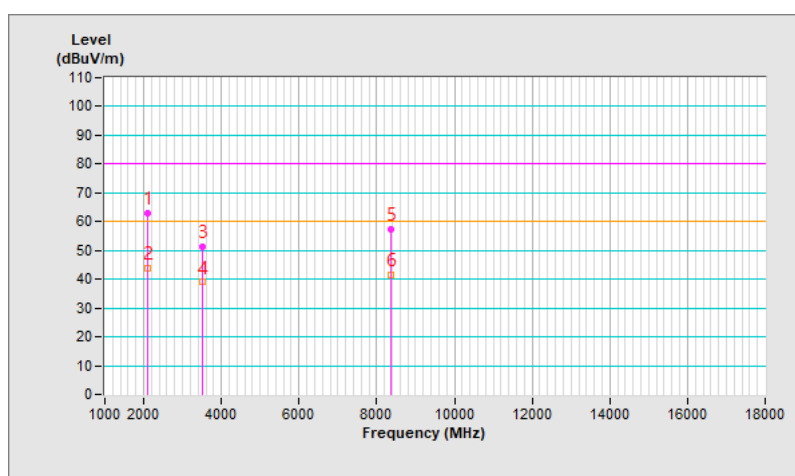

Frequency Range	1 GHz ~ 18 GHz	Detector Function & Resolution Bandwidth	Peak (PK) / Average (AV), 1 MHz
Input Power	120 Vac, 60 Hz	Environmental Conditions	22 °C, 78 % RH, 1000.8 mbar
Tested By	Desmond Chen		

Antenna Polarity & Test Distance : Vertical at 3 m								
No	Frequency (MHz)	Emission Level (dBuV/m)	Limit (dBuV/m)	Margin (dB)	Antenna Height (m)	Table Angle (Degree)	Raw Value (dBuV)	Correction Factor (dB/m)
1	2090.36	57.62 PK	80.00	-22.38	1.89 V	77	76.80	-19.18
2	2090.36	38.70 AV	60.00	-21.30	1.89 V	77	57.88	-19.18
3	3492.85	61.81 PK	80.00	-18.19	1.61 V	85	76.93	-15.12
4	3492.85	42.14 AV	60.00	-17.86	1.61 V	85	57.26	-15.12
5	5577.57	50.00 PK	80.00	-30.00	1.45 V	17	62.93	-12.93
6	5577.57	37.30 AV	60.00	-22.70	1.45 V	17	50.23	-12.93
7	8375.95	54.20 PK	80.00	-25.80	1.63 V	20	63.29	-9.09
8	8375.95	40.93 AV	60.00	-19.07	1.63 V	20	50.02	-9.09

Remarks:

1. Emission Level(dBuV/m) = Raw Value(dBuV) + Correction Factor(dB/m)
2. Correction Factor(dB/m) = Antenna Factor (dB/m) + Cable Factor (dB) – Pre-Amplifier Factor (dB)
3. Margin value = Emission level – Limit value
4. The other emission levels were very low against the limit.

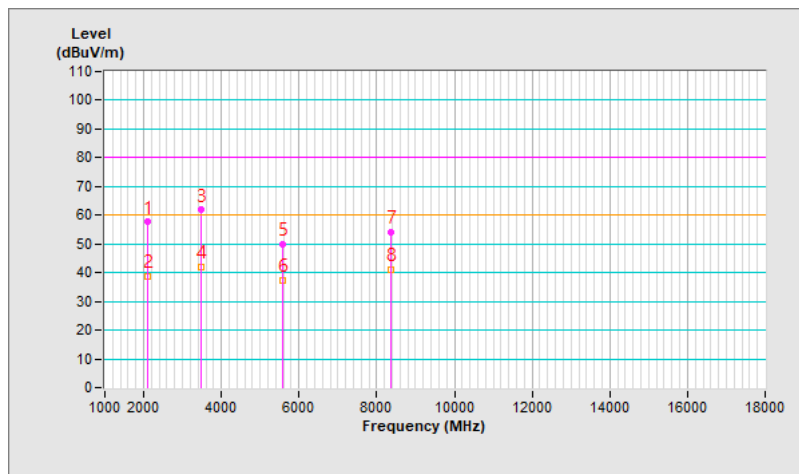

8 Pictures of Test Arrangements

8.1 Conducted Emissions from Power Ports

Mode A

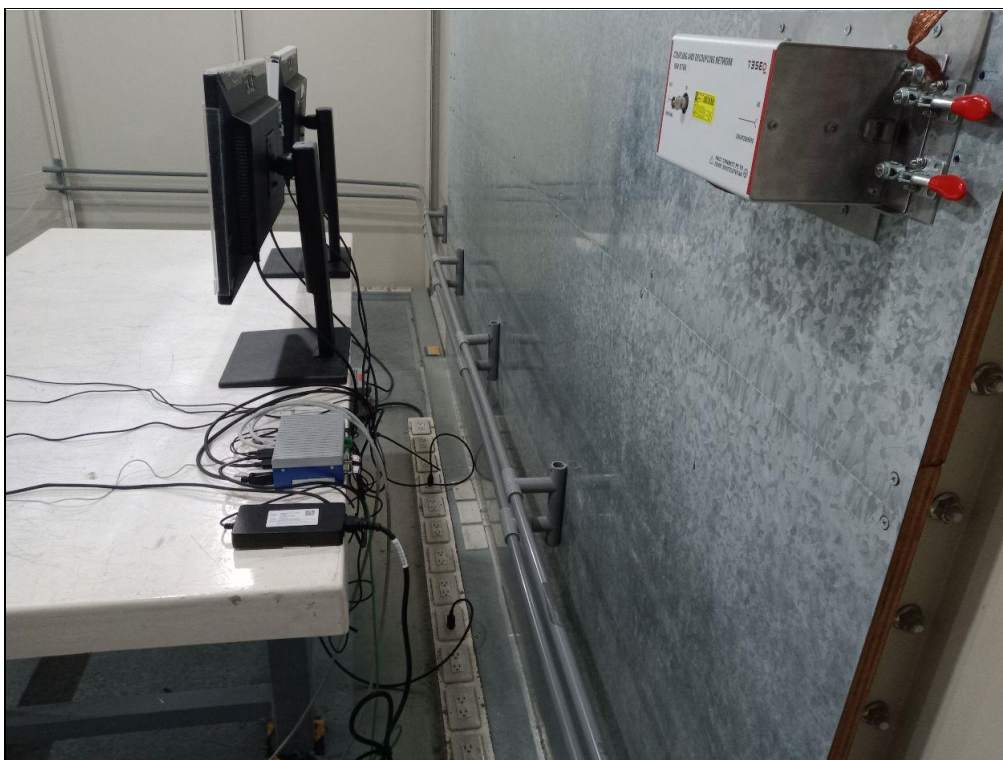

Mode B

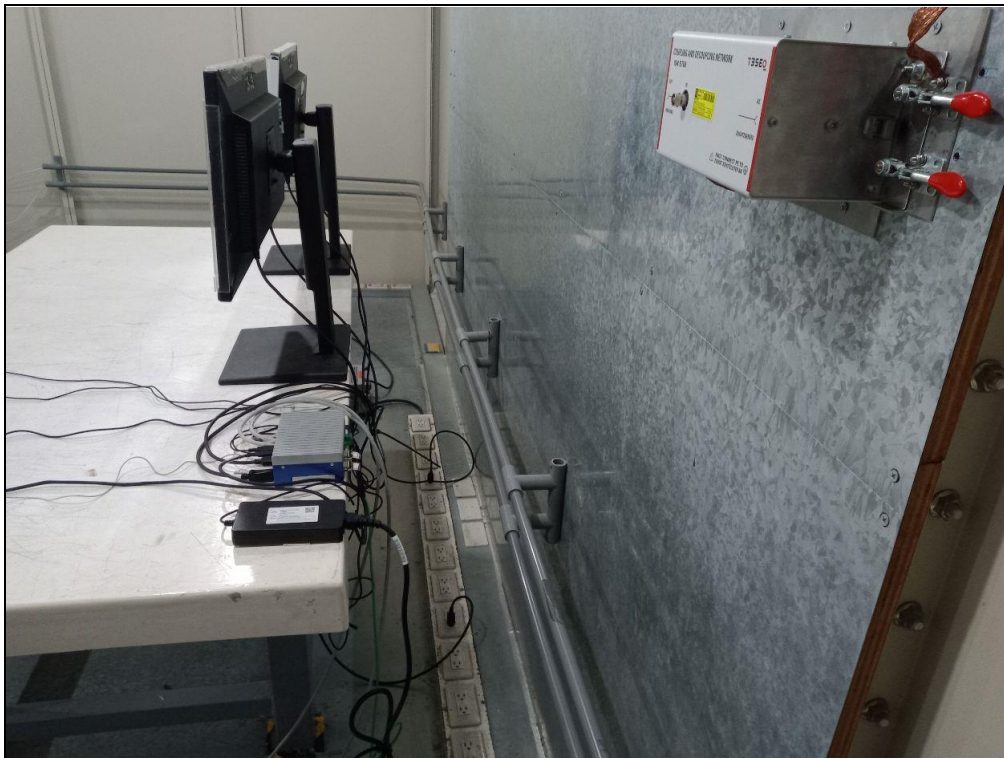

8.2 Radiated Emissions up to 1 GHz

Mode A



8.3 Radiated Emissions above 1 GHz

Mode A

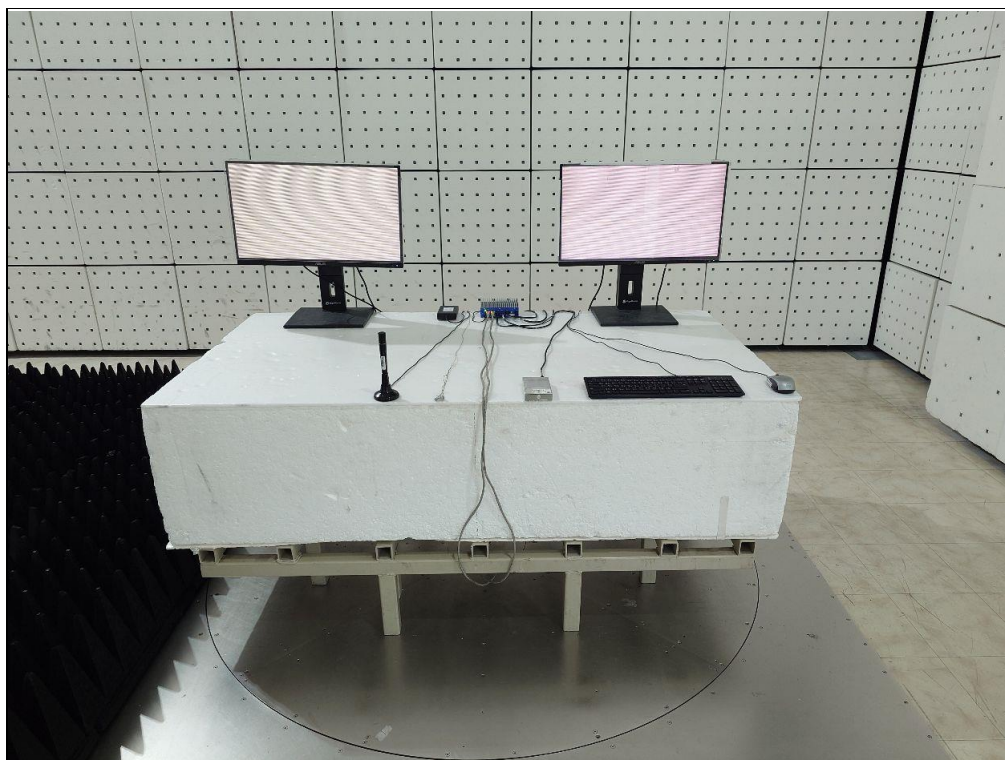

9 Information of the Testing Laboratories

We, Bureau Veritas Consumer Products Services (H.K.) Ltd., Taoyuan Branch, were founded in 1988 to provide our best service in EMC, Radio, Telecom and Safety consultation. Our laboratories are FCC recognized accredited test firms and accredited according to ISO/IEC 17025.

If you have any comments, please feel free to contact us at the following:

Lin Kou EMC/RF Lab

Tel: 886-2-26052180

Fax: 886-2-26051924

Hsin Chu EMC/RF/Telecom Lab

Tel: 886-3-6668565

Fax: 886-3-6668323

Hwa Ya EMC/RF/Safety Lab

Tel: 886-3-3183232

Fax: 886-3-3270892

Email: service.adt@bureauveritas.com

Web Site: <http://ee.bureauveritas.com.tw>

The address and road map of all our labs can be found in our web site also.

--- END ---